

ESP12

U6

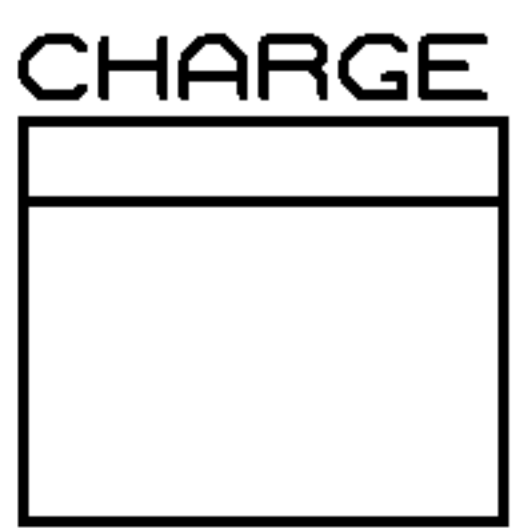

+12V
Gnd

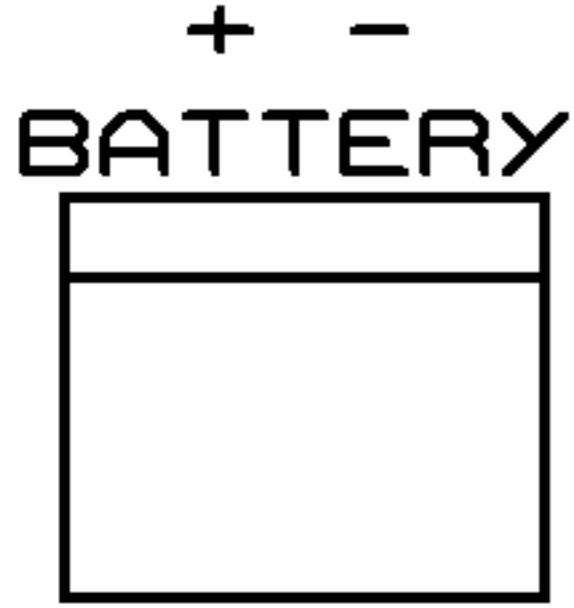
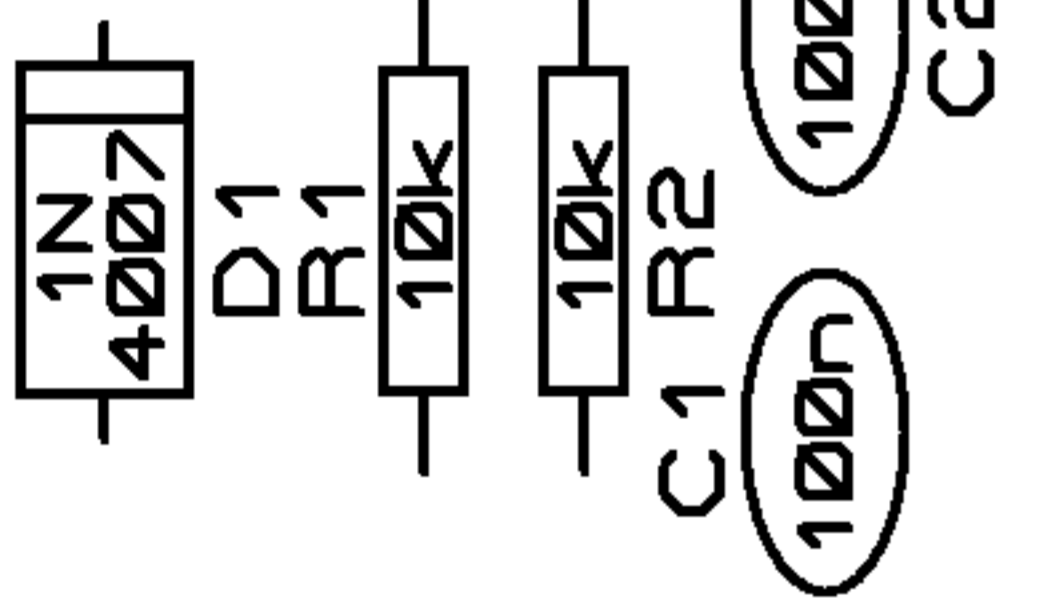
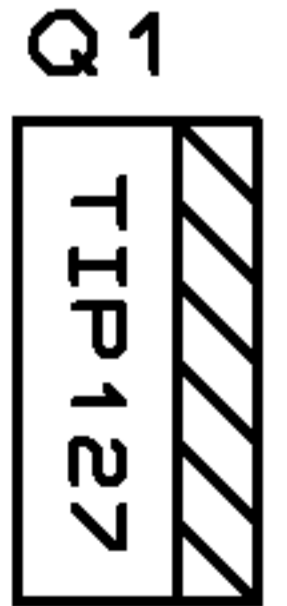

C16
220uF

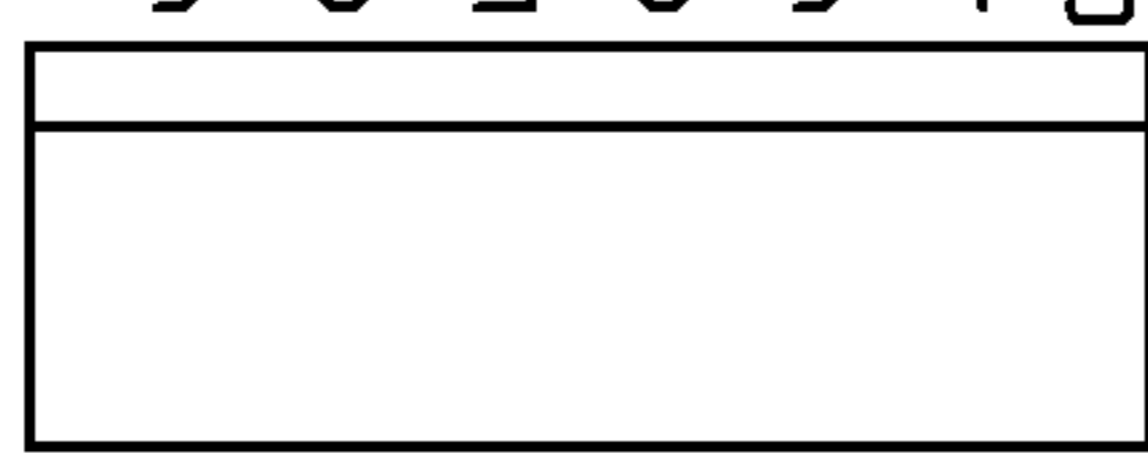
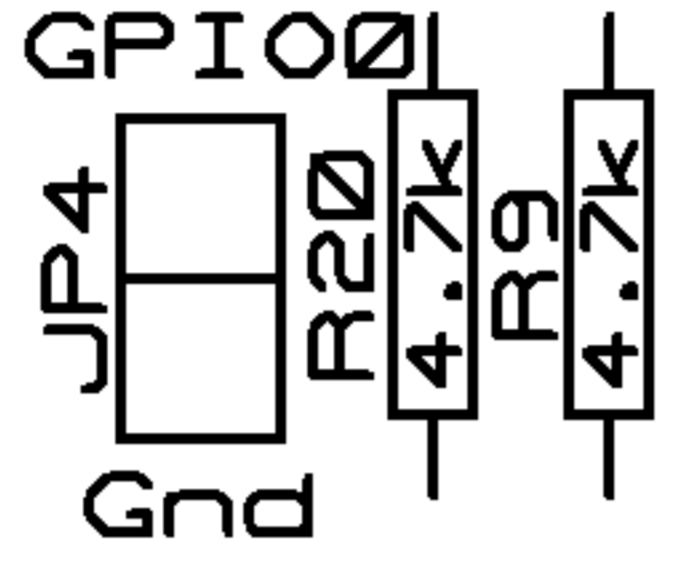
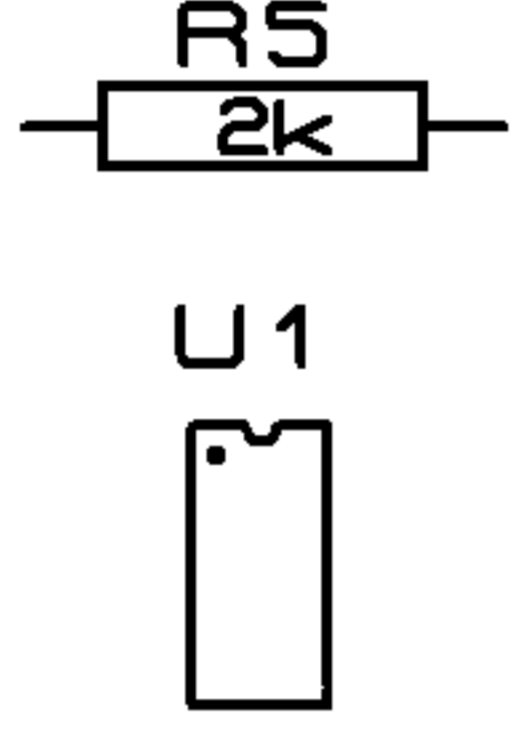
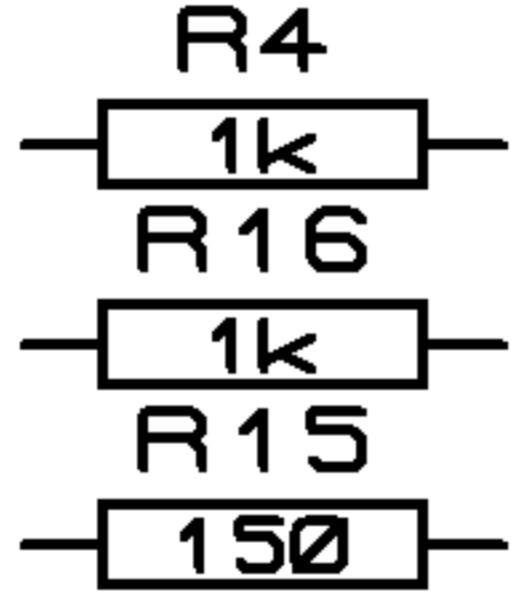

V-Led
Gnd
Led

C15
100n

Gnd

Vout
+5V
Vout2
Vout1

C3
100n

C4
100uF

C5
100n

C6
100uF

C14
10uF

C13
100n

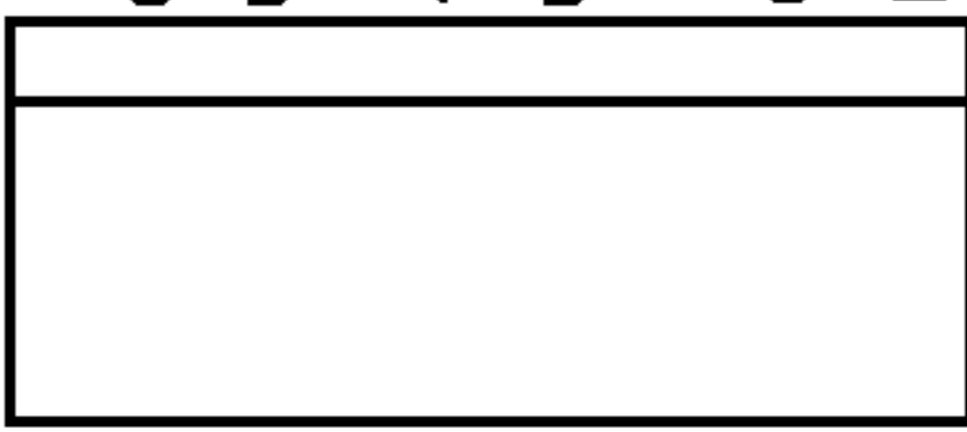
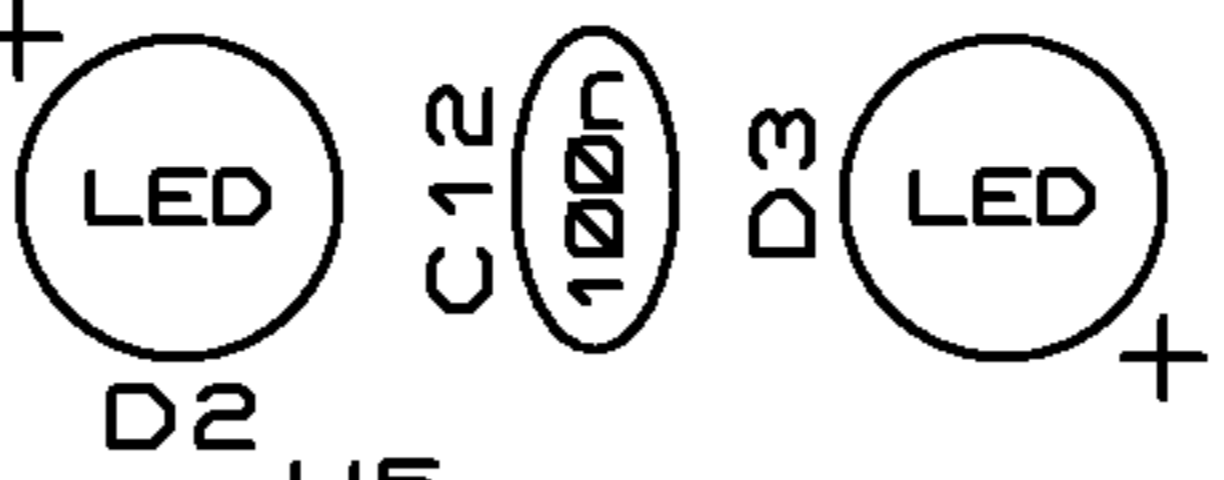
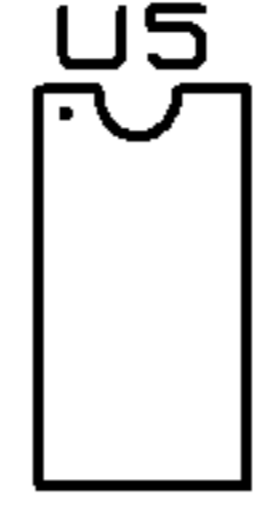

Control1
Vout2
+5V
Vout1

GREENPEACE

Dust Meter

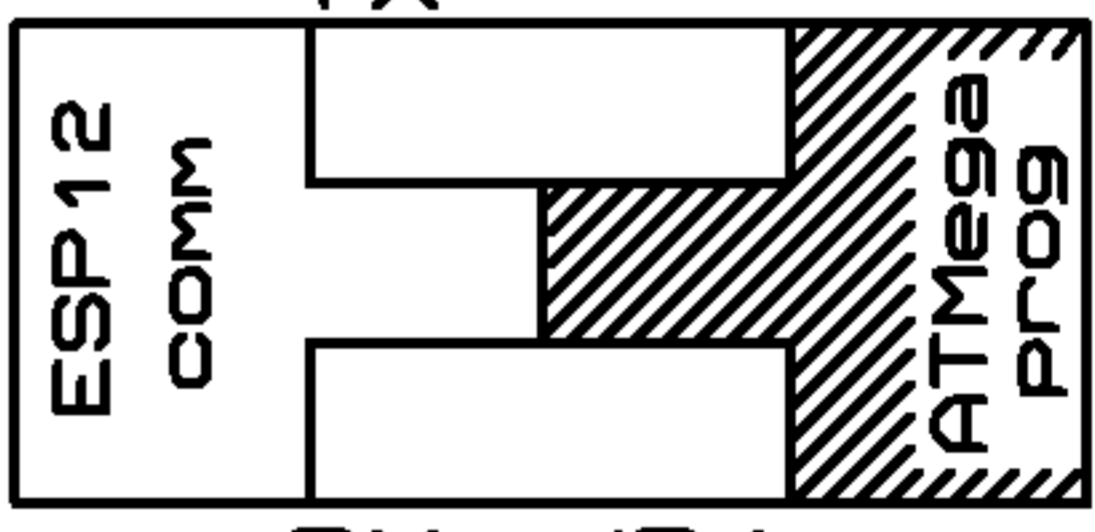

ESP12
COMM
RX
TX

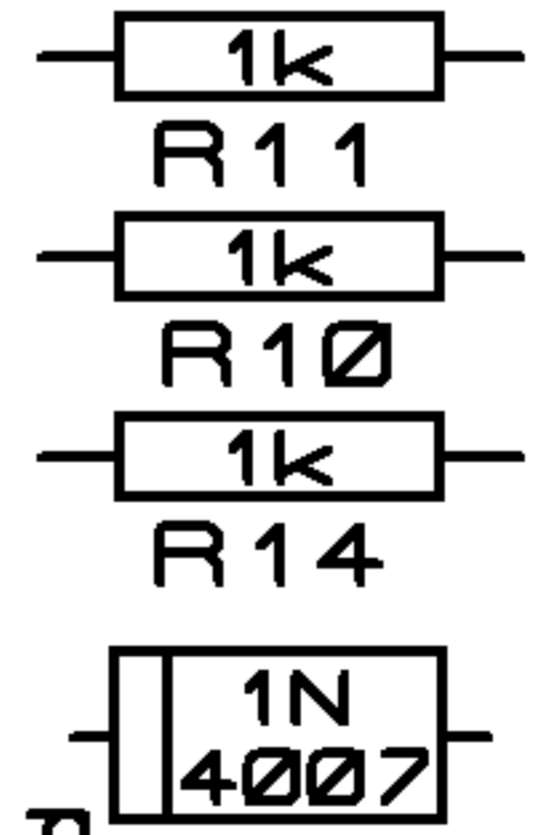

Gnd
U2
U3

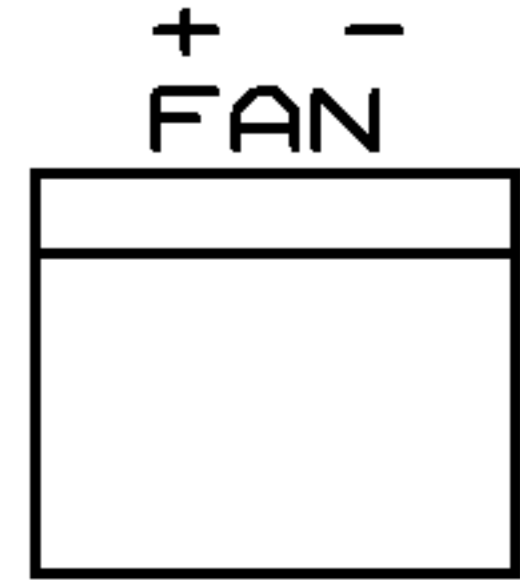

Q2
ZTX320

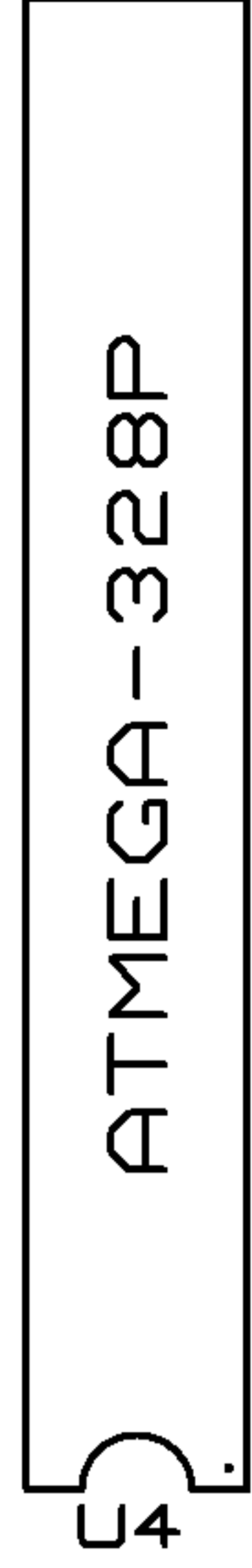

ATMEGA-328P

C10
100n

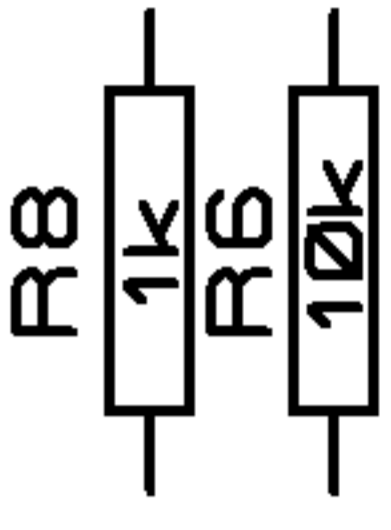

X1

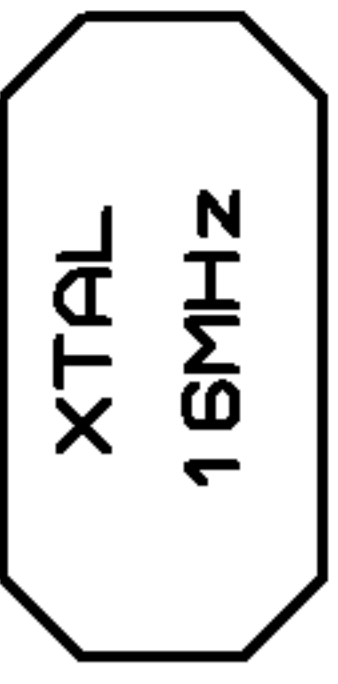

C10
100n

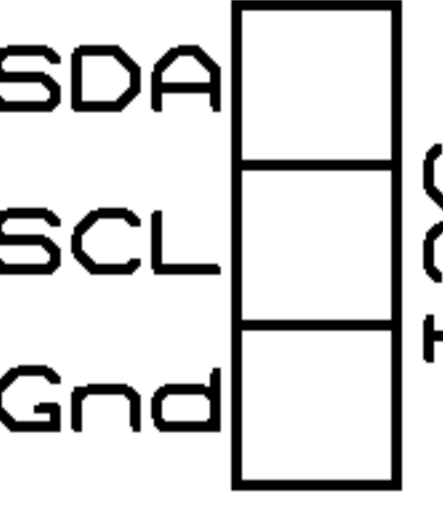

I2C

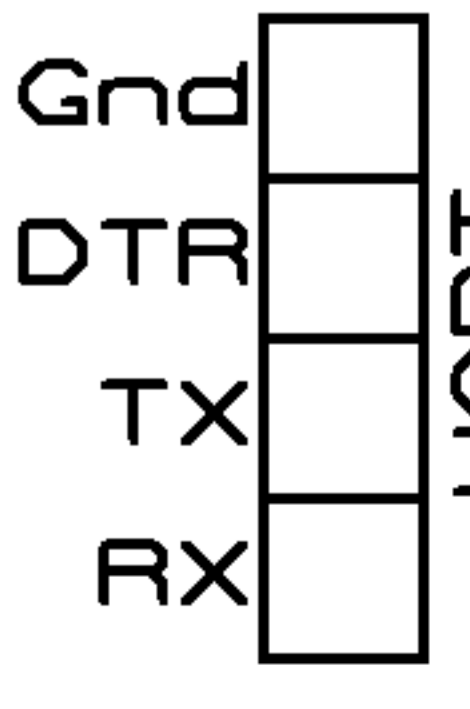

UART

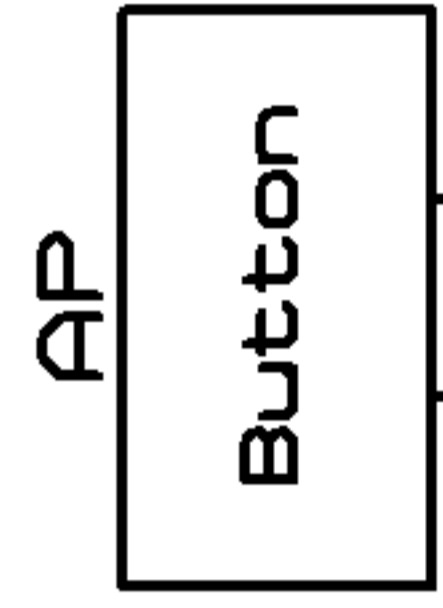

AP



RES

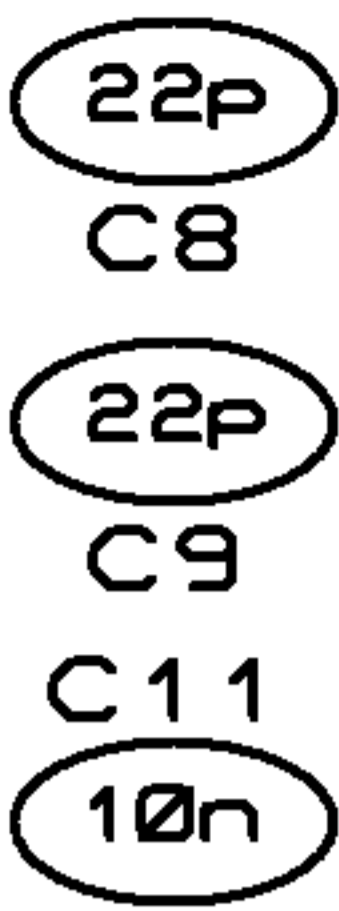

C11
10n

C9
22p

C8
22p